

DALIPro User Guide

Contents

1. DALIPro overview-----	2
2. Operation requirement-----	2
3. Active window-----	3
4. Commission-----	4
4.1 General process -----	4
4.1.1 Commissioning off-line then exporting on-line -----	4
4.1.2 Commissioning on-line-----	4
4.2 Project menu-----	5
4.2.1 Create new project off-line-----	5
4.2.2 Open project file off-line -----	5
4.2.3 Import data from system on-line -----	5
4.2.4 Export project to system on-line -----	6
4.3 Control Gear commissioning-----	7
4.3.1 Control Gear addressing and naming -----	7
4.3.2 Group setting-----	8
4.3.3 Scene setting -----	9
4.3.4 Control Gear parameterizing-----	10
4.3.5 Control Gear testing-----	12
4.4 Control Device commissioning -----	13
4.4.1 Control Device addressing and naming -----	13
4.4.1.1 MC(Button) addressing -----	13
4.4.1.2 Sensor addressing and identifying -----	14
4.4.1.3 Address changing and deleting-----	14
4.4.1.4 Control Device naming -----	15
4.4.2 Control Device parameterizing -----	15
4.4.2.1 MC (Button) parameterizing -----	15
4.4.2.2 Motion Sensor parameterizing -----	18
4.4.2.3 Daylight Sensor parameterizing -----	19

1. DALIPro overview

DALIPro is a dedicated software for debugging and configuring of DALI lighting control system. The software is used for configuring the DALI Control Gears (such as DALI LED driver, etc.), along with series of DALIPro Control Devices (such as DALI MC series and DALI sensors).

Its main functions include:

- Addressing, testing, parameterizing and monitoring DALI Control Gears
- Configuring groups and scenes for DALI Control Gears.
- Addressing and parameterizing for Control Devices.
- Planning and editing off-line or on-line project.
- Exporting project file to DALI system o-line.

2. Operation requirement

- Windows 7 or newer operating system.
- DALI system that consists of DALI PS (DALI Bus Power Supply), Control Gears and Control Devices.
- DALI-USB or DALI-Wifi gateway for connecting PC to DALI bus.

[DALI System Composition](#) Diagram

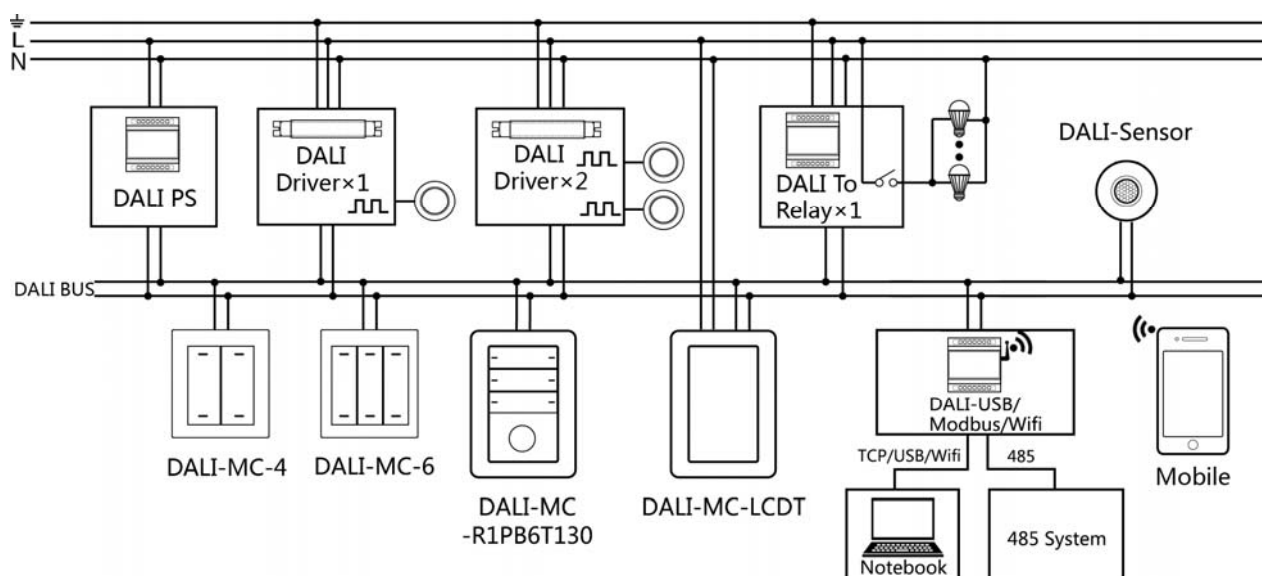

3. Active window

Below is an user interface from DALIPro V1.0. Actual appearance may be different than the following picture depending on different versions used.

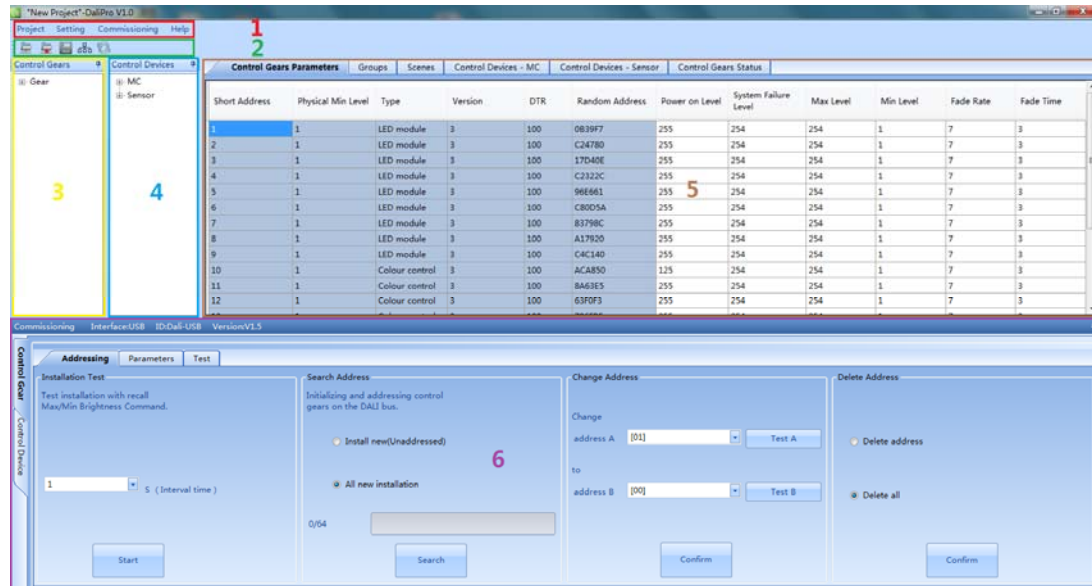







Table 1: Active window parts description

Parts	Description
1. Menu Bar	Contains Project, Setting, Commissioning and Help menus.
2. Tool Bar	Contains shortcut keys for accessing various functions.
3. Control Gears Tree	Displays names and short addresses of all Control Gears in the system.
4. Control Devices Tree	Displays names and short addresses of all Control Devices in the system.
5. Data Table	Displays and conducts the configurations of the following: <ul style="list-style-type: none"> 1. Parameters of Control Gears. 2. Groups of Control Gears. 3. Scenes of Control Gears. 4. Parameters of Control Devices-MC. 5. Parameters of Control Devices – Sensor. 6. Control Gear Status.
6. Commissioning Bar	1. Addresses, parameterizes and testing for Control Devices. 2. Addresses and parameterizes for Control Devices.



Table 2: Tool bar description

Icon	Function	Function description
	On-line import	Imports a DALI project file into a connecting DALI system.
	Off-line open	Views and edits a DALI project file while disconnecting to DALI system.
	Save as	Saves the currently edited DALI project as a file with specified name and location.
	Import data from system on-line	Selects a standard communication interface (USB or Wifi) to access a DALI system.
	Refresh	Reconnects system and read the contents on current page.

4. Commission

4.1 General process

4.1.1 Commissioning off-line then exporting on-line

Step1. Run DALIPro software.

Step2. Create new project off-line as refer to chapter4.2.1.

Step3. Save the project file while commissioning (parameterizing and configuring) of Control Gears and Devices finished.

Step4. Connect to a DALI system and run < Import data from system on-line> as refer to chapter4.2.3.

Step5. As refer to chapter4.3.1, run <Installation Test> and <Search Address> procedures for all Control Gears on-line, make sure the total number of DALI gear addresses is the same as in above project file you saved.

Step6. Export project to DALI system on-line as refer to chapter4.2.4.

4.1.2 Commissioning on-line

Step1. Connect to a DALI system and run < Import data from system on-line> as refer to chapter4.2.3.

Step2. Run <Installation Test> and <Search Address> procedures for all Control Gears.

Step3. Parameterize and configure all the Control Gears as needed.

Step4. Address all the Control Devices (DALI MC or DALI sensor etc.).

Step5. Parameterize and configure all the Control Devices as needed.

Step6. Test the actual system to make sure all the commissions work meeting the user's requirement.

Step7. Save the project as a file for backup and future use.

4.2 Project menu

4.2.1 Create new project off-line

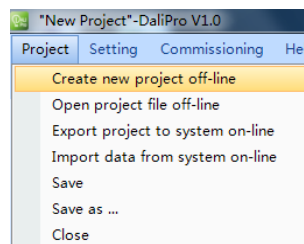

Step1. Start by clicking “Create new project off-line”.

Step2. Create new gears and devices by right-clicking the root of the tree structures.

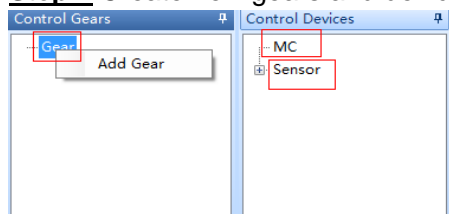

Select “Type” and “Address” of new gear or device, press “ADD” button to finish the adding.

Step3. Rename gears and devices for easy identification.

Step4. Configure groups and scenes for Control Gears: refer to chapter 4.3.2 and 4.3.3 for details.

Step5. Parameterize Control Gears: refer to chapter 4.3.4 for details.

Step6. Parameterize Control Devices: refer to chapter 4.4.2 for details.

Step7. Save as a project file by clicking “Save as” from “Project” menu.

4.2.2 Open project file off-line

Step1. Click  and selects an existing DALI project file .

Step2. All the parameters of the file can be edited and saved.

4.2.3 Import data from system on-line

Step1. Click  and chooses the interface . If “USB” is chosen, skip

Step2.

Step2. If “WIFI” is chosen, makes sure the computer is connecting the correct WIFI of accessing the gateway. For DALI-Wifi gateway configuration, refers to the “User’s Manual of DALI-USB/LAN/Wifi Gateway”.

Step3. Choose whether to import the unaddressed Control Gears.

Step4. Choose the “All read” or “Quick read”. “All read” may take more minutes, “Quick read” will not read the information of groups and scenes temporarily.

4.2.4 Export project to system on-line

4.2.4.1 Control Gear exporting:

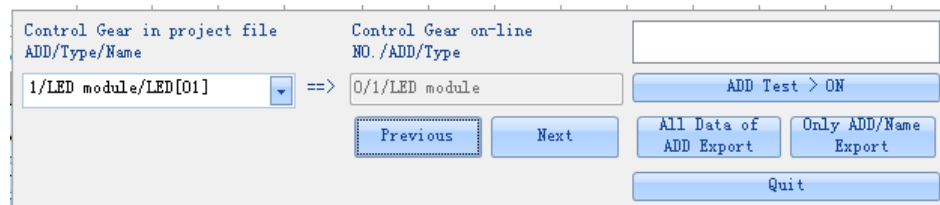

Step1. Click  and open an existing DALI project file. The Control Gear exporting dialog box will be shown as above.

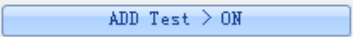

Step2. Click  to turn ON/OFF the on-line Control Gear for

identification, then select the matched Control Gear in  for

exporting to , click  to confirm the exporting action.

The On-line gear will shift to the next one automatically when the exporting is finished.

Step3. Repeats step2. until all the Control Gears are exported correctly. User can click

  to select specific on-line Control Gear for exporting individually.

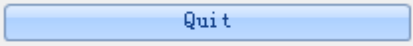
Step4. Click .

Step5. Choose  to export Control Devices or choose  to quit the exporting action.

4.2.4.2 Control Device (MC button) exporting:

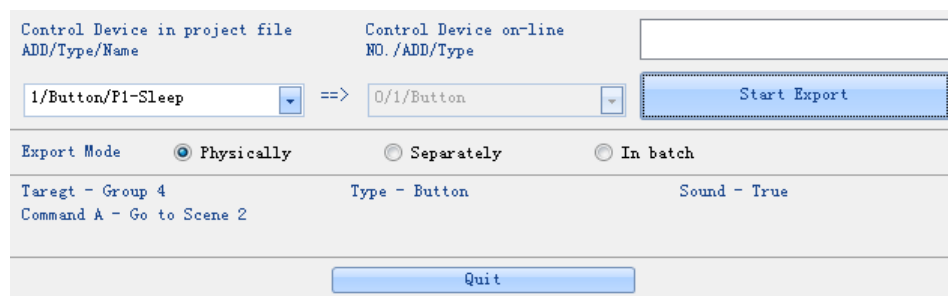

Step1. Choose Export Mode as needed.

Mode	Description
Physically	For indentifying which button will be imported, user needs to physically press the selected button.
Separately	To be used when the buttons are addressed. User needs to select the corresponding button from project file for exporting to a on-line button.
In batch	To be used when all the buttons are addressed. All the buttons will be exported sequentially. Make sure the number and order for both in project file and on-line DALI system are correctly matched.

Step2. Press  button, user who chooses physically mode need to press the matched button in DALI on-line system for confirmation. Click

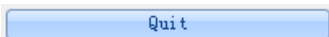

 while all the buttons are exported correctly.

4.3 Control Gear commissioning

4.3.1 Control Gear addressing and naming

In commissioning bar, select the **Control Gear/Addressing** page.



Part1. Installation Test. Click  to conduct Max/Min power command test on all Control Gears that have been installed so as to ensure all Control Gears are installed and powered on correctly. Test can be ended by clicking .

Part2. Search Address. The user can search the Control Gears in connecting DALI system, and then assign short addresses for them. There are two options for Control Gears addressing:

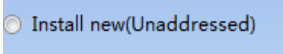
1. **Install new (Unaddressed).**  While implementing this option, searching and automatic assigning short address will be performed only on the Control Gears without short address in the system.

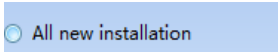

2. **All new installation.**  While implementing this option,



searching and automatic assigning short address will be performed on all Control Gears (no matter if short addresses have been assigned) in the system.

Click  to start searching and short addresses (0-63) assigning automatically. The

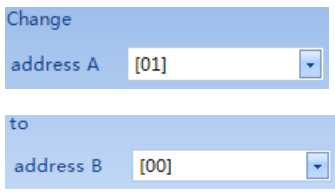
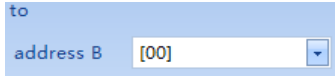

Control Gears with short address will be displayed in Control Gear tree. Click  to stop or end searching.

Part3. Change Address. Select a short address A of Control Gear

 , then select another specified short address B to  . click  to confirm the short address A exchange with B.

Click  or  to identify the location of short address A or B.

Part4. Delete Address

- **Delete address:** Select  . Choose the address to be deleted in the drop-down box, and then click  to confirm delete operation.

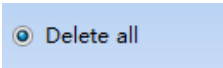
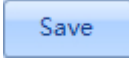
- **Delete all:** Select  , then click  to confirm the deletion of all short addresses of Control Gears.

Part5. Naming the Control Gear of Short Address

On the Control Gear tree, right click to select a specific Control Gear, click “rename” option, type a description text and click “Enter” key to assign a name to this Gear for easy identification.

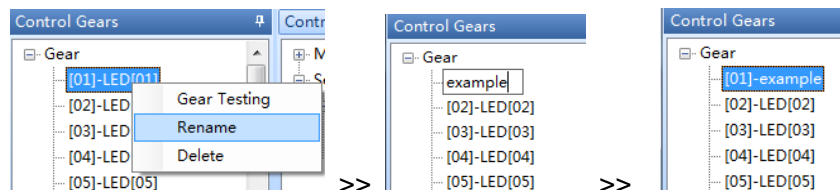

4.3.2 Group setting

Address types of DALI Control Gear:

ADD: Short Address (Individual)	Each Control Gear can be assigned and controlled by individual short address. Range of short address is 0-63.
Group	Each Control Gear can be assigned to certain groups, so the DALI group would be regarded as the controlling target of

	certain Control Gears. Range of group address is 0-15.
ALL (Broadcast)	As the controlling target of all Control Gears in the system.

Group address: If the same DALI command needs to be performed on several Control Gears, these Control Gears can be assigned to one Group address as a group member, then every DALI command with this assigned Group address will perform by its group members.

Group name: On Groups page of data table, user can right click on the top labels(G0-G15) to assign a description name for each group.

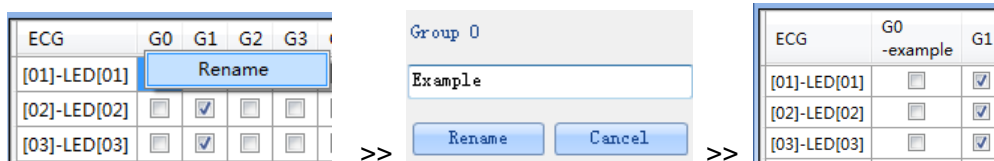

Group assignment: On Groups page of data table, user can check boxes to assign each Control Gears to whatever group address from 0 to 15 directly.

Control Gears Parameters	Groups	Scenes	Control Devices - MC	Control Devices - Sensor										
ECG	G0	G1	G2	G3	G4	G5	G6	G7	G8	G9	G10	G11	G12	G13
	-Bathroom	-Corridor	-Ceiling	-Table	-Room	-	-	-	-	-	-	-	-	-
[03]-ECG[03]	<input type="checkbox"/>	<input checked="" type="checkbox"/>	<input type="checkbox"/>	<input type="checkbox"/>	<input checked="" type="checkbox"/>	<input type="checkbox"/>	<input type="checkbox"/>	<input type="checkbox"/>	<input type="checkbox"/>	<input type="checkbox"/>	<input type="checkbox"/>	<input type="checkbox"/>	<input type="checkbox"/>	<input type="checkbox"/>
[04]-ECG[04]	<input type="checkbox"/>	<input checked="" type="checkbox"/>	<input type="checkbox"/>	<input type="checkbox"/>	<input checked="" type="checkbox"/>	<input type="checkbox"/>	<input type="checkbox"/>	<input type="checkbox"/>	<input type="checkbox"/>	<input type="checkbox"/>	<input type="checkbox"/>	<input type="checkbox"/>	<input type="checkbox"/>	<input type="checkbox"/>
[05]-ECG[05]	<input type="checkbox"/>	<input type="checkbox"/>	<input type="checkbox"/>	<input type="checkbox"/>	<input checked="" type="checkbox"/>	<input type="checkbox"/>	<input type="checkbox"/>	<input type="checkbox"/>	<input type="checkbox"/>	<input type="checkbox"/>	<input type="checkbox"/>	<input type="checkbox"/>	<input type="checkbox"/>	<input type="checkbox"/>
[06]-ECG[06]	<input checked="" type="checkbox"/>	<input type="checkbox"/>	<input type="checkbox"/>	<input type="checkbox"/>	<input type="checkbox"/>	<input type="checkbox"/>	<input type="checkbox"/>	<input type="checkbox"/>	<input type="checkbox"/>	<input type="checkbox"/>	<input type="checkbox"/>	<input type="checkbox"/>	<input type="checkbox"/>	<input type="checkbox"/>
[07]-ECG[07]	<input checked="" type="checkbox"/>	<input type="checkbox"/>	<input type="checkbox"/>	<input type="checkbox"/>	<input type="checkbox"/>	<input type="checkbox"/>	<input type="checkbox"/>	<input type="checkbox"/>	<input type="checkbox"/>	<input type="checkbox"/>	<input type="checkbox"/>	<input type="checkbox"/>	<input type="checkbox"/>	<input type="checkbox"/>

4.3.3 Scene setting

Scene number: A DALI lighting control system allows the user to configure up to 16 scenes (0–15).

Scene description name: On Scenes page of data table, user can right click on the top labels(S0-S15) to assign a description name for each scene.

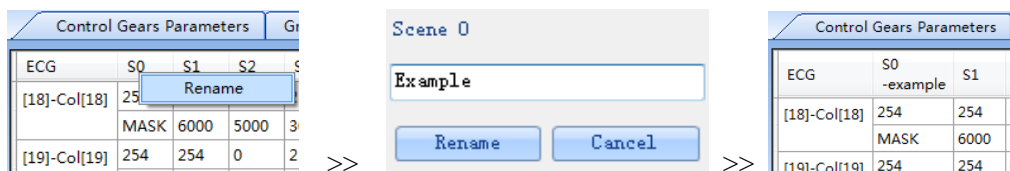

Scene setting: On Scenes page of data table, user can directly input the intensity (0-254,255=Mask) of each Control Gear to whatever scene number from 0-15. For Control Gear type8, user can even input the color temperature value (3000-6000,65535=Mask)K.

Note!

MASK means that the Control Gears in this scene will retain their current intensity or color temperature status when the relevant scene is recalled.

Setting in batch: Left click a cell then drag (or hold down the "Shift" key and press direction keys) to select the consecutive cells (can also hold down the "Ctrl" key, then left-click the certain cells), then enter the desired value into the last cell ,the value entered will change all the cells that are same type of the last cell.

	S0	S1	S2	S3	S4	S5	S6
ECG	-	-Bright	-sleep	-Soft	-TV	-Guest	-
[13]-Col[13]	254	254	0	254	0	150	254
	MASK	6000	MASK	3000	4500	4000	4000
[14]-Col[14]	254	254	0	254	0	150	0
	MASK	6000	3000	3000	4500	4000	MASK
[15]-Col[15]	254	254	0	254	100	150	0
	MASK	6000	MASK	3000	3000	4500	MASK
[16]-Col[16]	254	254	0	254	100	150	0

0%(min) - 100%(max) 0(min) - 254(max)

Intensity expression: At bottom of the Scenes page, user can select the expression of intensity by level (0~254) or percentage (0%~100%).

4.3.4 Control Gear parameterizing

General Parameterizing: User can set or modify basic parameters of Control Gear in two different means.

Means 1: On page of Control Gear \ Parameters in commission bar.

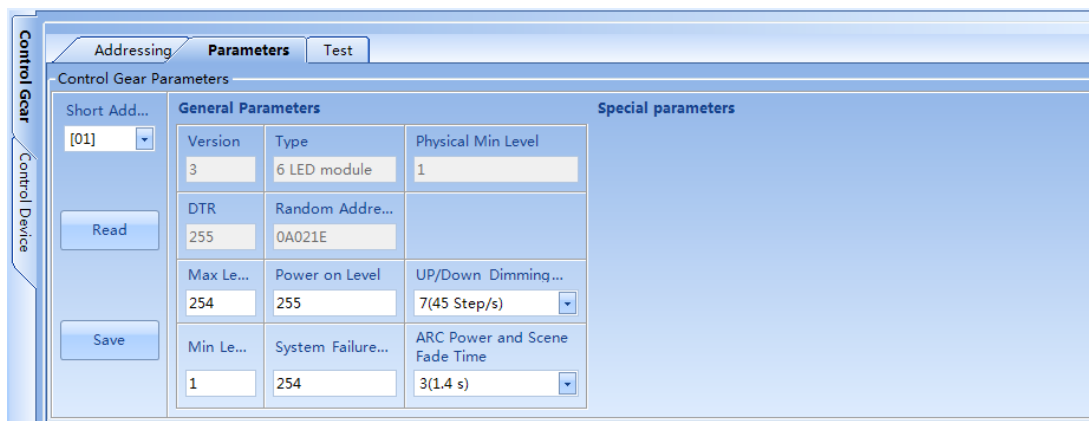

On this page, select a short address of Control Gear and edit all basic parameters of this Control Gear.

Means 2: All basic parameters of each Control Gear can be input on page of **Control**

Gears Parameters data table directly.

Control Gears Parameters												
Groups			Scenes			Control Devices			Control Gears Status			
	Short Address	Physical Min Level	Type	Version	DTR	Random Address	Power on Level	System Failure Level	Max Level	Min Level	Fade Rate	Fade Time
▶	0	1	Colour...	9	0	030A32	254	254	254	1	7	0
	1	1	Colour...	9	0	0397BF	254	254	254	1	7	2
	2	1	Colour...	9	0	068893	254	254	254	1	7	2
	3	1	Colour...	9	0	0A446C	254	254	254	253	15	15
	4	1	Colour...	9	0	1964C6	254	254	254	1	7	2
	5	1	Colour...	9	0	20C207	254	254	254	1	7	0

Explanation of Basic Parameters of Control Gear:

Parameter name	Description	Can be edited or not
Short Address	Short address of Control Gear with a range of 0-63.	Yes
Physical Min Level	Level of physical (inherent) minimum output power of Control Gear.	No
Type	Device type of Control Gear.	No
Version	Version No. of Control Gear.	No
DTR	Value in data transfer register (DTR) of Control Gear.	No
Random Address	Random address generated while initializing addressing of Control Gear.	No
Power on Level	The selected value is set as the value after power is restored.	Yes
System Failure Level	The selected value is set as the value in the event of failure of the DALI power supply or DALI bus.	Yes
Max Level	The selected value is set as the maximum level for the Control Gear. This value cannot be exceeded during brightening.	Yes
Min Level	The selected value is set as the minimum level for the Control Gear. This value cannot be fallen below during dimming.	Yes
Fade Rate	The selected value is set as the dimming speed. It indicates by how many steps per second the intensity is changed. The Fade Rate is used with the DALI commands Brighten (Up) and Dim (Down).	Yes
Fade Time	The selected value is set as the fade time in seconds for scene or output power being changed.	Yes

4.3.5 Control Gear testing

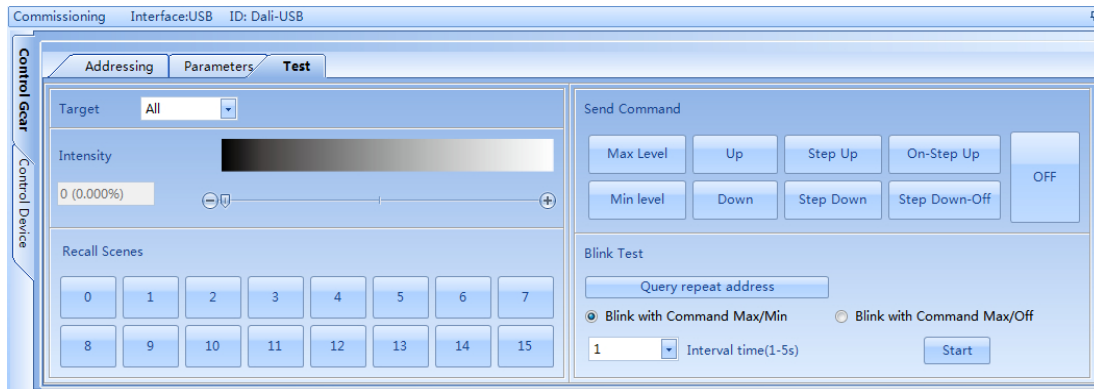

Select page of **Control Gear \ Test** in commission bar.

Test targets can be selected as “All, Group and Address” 

To selected test targets of Control Gears, the following tests can be conducted:

1. Instant power (intensity) test.



2. Recall scene0-15.

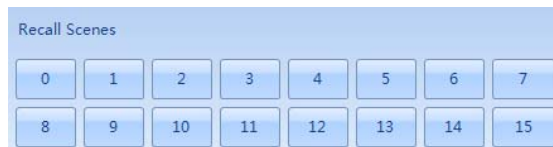

3. Command test, including Max Level, Min Level, Up, Down, Step Up, Step down, On-Step Up, Step Down-Off and Off.



4. Send Command Max Level/Min Level or Max Level/Off alternately with specified interval time to check if the Control Gears are properly installed, power supplied and able to receive DALI commands correctly.

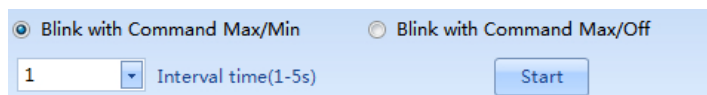

5. Based on the system address list, send maximum/minimum instant power commands alternately with specified interval to test Controlled gear if any duplicate address exists or assigned wrong.

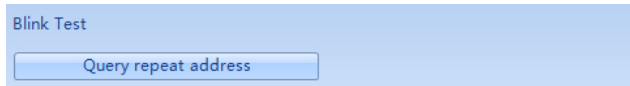

4.4 Control Device commissioning

4.4.1 Control Device addressing and naming

4.4.1.1 MC(Button) addressing

In commissioning bar, select the Control Device \ Addressing page.

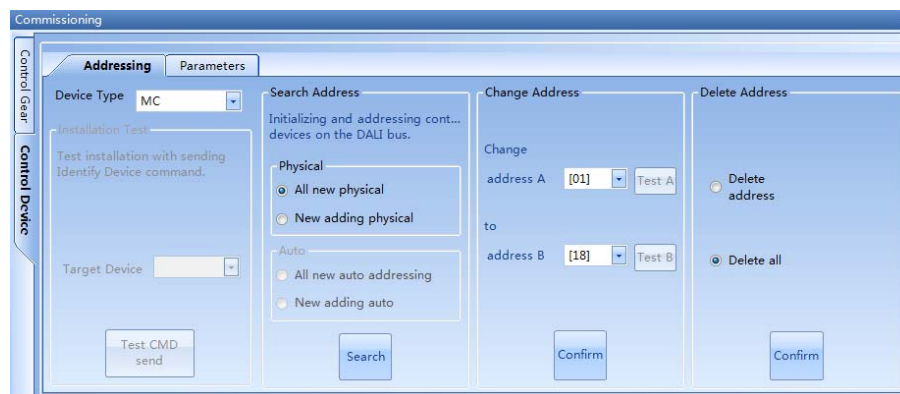

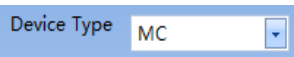
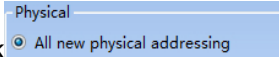

Option1: All new physical addressing. On page of Control Device \ Addressing in

commission bar, select “MC” , check ,

click  and then click MC buttons that need to be assigned with short address one by one manually. Hint window will be popped up when a short address is assigned to the

button successfully. Click  to finish all assignments. All MC buttons that have short address will be displayed on the Control Device tree and data table.

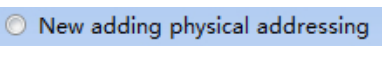
Option2: New adding physical addressing. On page of Control Device \ Addressing in



commission bar, check , click  and then click MC buttons that need to be assigned with short address one by one manually. Please be



noted that only buttons without short address will be assigned successfully. Click  to end searching MC buttons. All new adding MC buttons with short address will be displayed on the Control Device tree and data table.

Note!

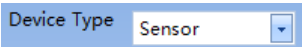
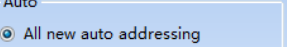
About the short address of Control Device: The short addresses of MC Buttons are separated from Control Gears and Sensors. In one DALI lighting system, there are 64 short addresses for MC Buttons at most.

4.4.1.2 Sensor addressing and identifying

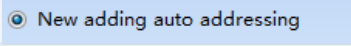
Option1: All new auto addressing. On page of Control Device \ Addressing, select “Sensor” in , click , While implementing this option, searching and automatic assigning short address will be performed on all Sensors (no matter if short addresses have been assigned) in the system. Click  to start the action automatically. All Sensors that have short address will be displayed on the Control Device/Sensor tree and data table.

Option2: New adding auto addressing. On page of Control Device \ Addressing, click , While implementing this option, searching and automatic assigning short address will be performed only on the Sensors without short address in the system. click  to start searching and assigning action.

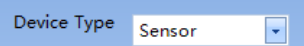
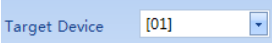
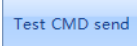



Identifying the Sensor In Device Type box , when “Sensor” is selected, user is able to select an address in , then press  to make the Sensor’s indicator light flashes, so the user is able to identify the location of the Target Sensor.

Note!

About the short address of Sensor: The short addresses of Sensors are separated from the Control Gears and MC buttons. In one DALI lighting system, there are at most 64 short addresses for Sensor, but for reliable and stable reason, we strongly suggest that no more than 16 Sensors are used in one DALI bus.

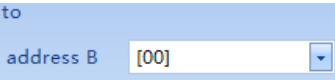

4.4.1.3 Address changing and deleting

Change Address

Select a short address A  of Control Device, then select another specified short address B . click  to confirm the short address A exchange with B. Click  or  to identify the location of short address A or B.

Delete Address

1. **Delete one address:** In the Delete Address bar,

select . Choose the address to be deleted in the drop-down box, and then click  to confirm delete operation.

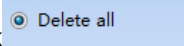
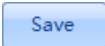
2. **Delete all address:** In the Delete Address bar, check , then click  to confirm the deletion of all short address.

4.4.1.4 Control Device naming

On the Control Device tree, right click to select a specific Control Device, click “rename” option, type a description text and click “Enter” key to assign a name to this Device for easy identification.

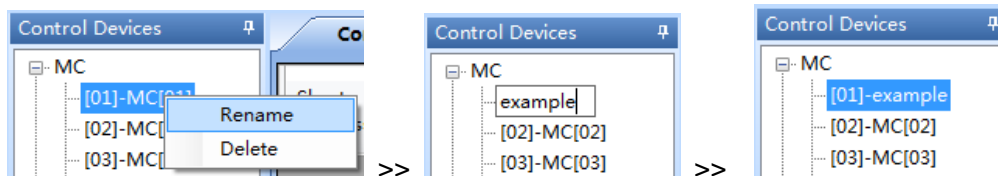

4.4.2 Control Device parameterizing

4.4.2.1 MC (Button) parameterizing

Step1. After all the Control Device have been assigned with short address, On page of Control Device \ Parameters in commission bar,

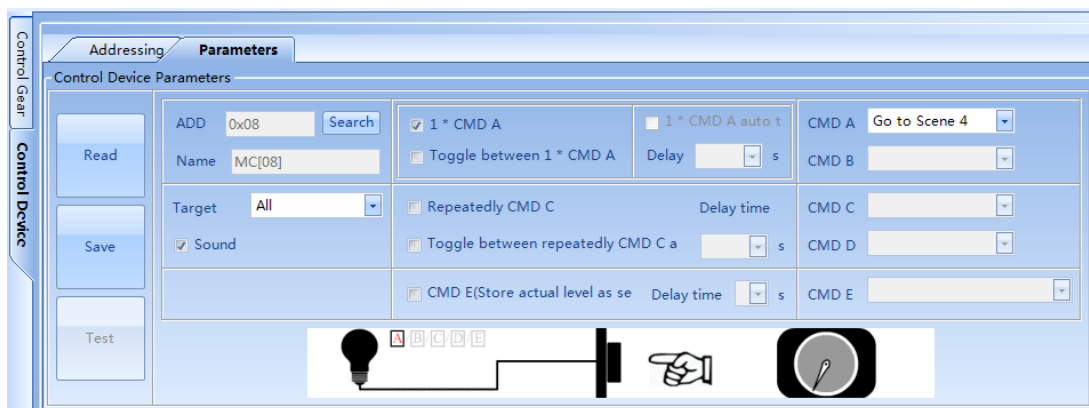

click  beside “ADD” to select the buttons need to be set, or click on the Control

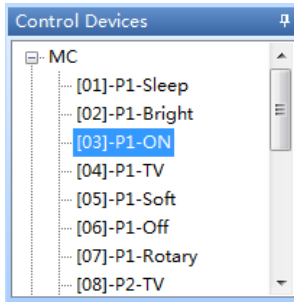

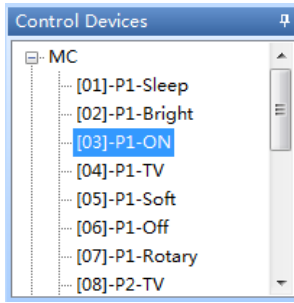
Device tree  to select a the specific MC button.

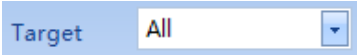
Step2. Select a Control Gear(s) address in  as the control target for this programmable MC button. If selecting “Group” or “Address”, a select

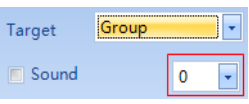
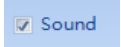
box  will be displayed for selecting the address number. If the checkbox  is selected, the button will make sounds while being clicked.

Step3. Set command to be sent after button being clicked.

1. Setting CMD sending mode

Four basic CMD(Command) sending modes that can be set are shown as follows:

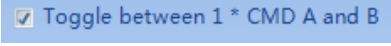
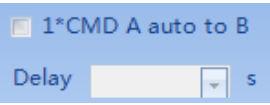
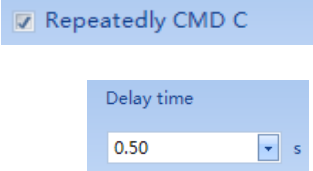
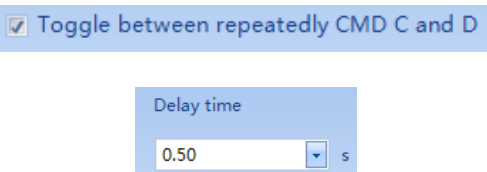
Command	Description
	1. CMD A will be sent once after clicking the button.
	2. Each time the button being clicked, CMD A and CMD B will be sent once alternately.
	3. After clicking the button, CMD A will be sent once, and after delay time set in Delay box, Command B will also be sent once automatically.
	4. After clicking and hold the button for longer than setting in Delay time box, Command C will be sent continuously and repeatedly until the button being released.
	5. Each time the button being clicked and held for longer than setting in Delay time box, CMD C and D will be sent continuously and repeatedly until the button being released.

2. Setting (DALI Command) CMD

The selections of CMD A, B, C and D. are shown as in following [DALI Commands](#) table:

No.	CMD(Command)	Function description
1	Off	The lighting is switched off immediately without any fade time.
2	Intensity(DAP)	The intensity specified in the command is recalled. The defined fade time will be used.
3	Recall max	The maximum level is recalled immediately without any fade time.
4	Recall min	The minimum level is recalled immediately without any fade time.
5	Go to Scene 0~15	Lighting Scene X (0~15) is recalled. The defined fade time will be used.
6	Step down and off	·If the lighting is switched on, the intensity is reduced by one step. ·If the lighting reaches the minimum level, it is switched off.
7	On and step up	·If the lighting is switched off, the minimum level is recalled. ·If the lighting is switched on, the intensity is increased by one step.
8	Up	The intensity is increased by the steps defined in the fade rate. When the lighting reaches the set maximum level, it remains at this level.
9	Down	The intensity is reduced by the steps defined in the fade rate. When the lighting reaches the set minimum level, it remains at this level.
10	Step down	The intensity is reduced by one step.
11	Step up	The intensity is increased by one step.

Step4. Save the Settings

On page of Control Device \ Parameters in commission bar, Click  to confirm

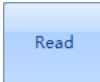
and save the setting of this MC button. User can click  to load all the settings from current MC button.

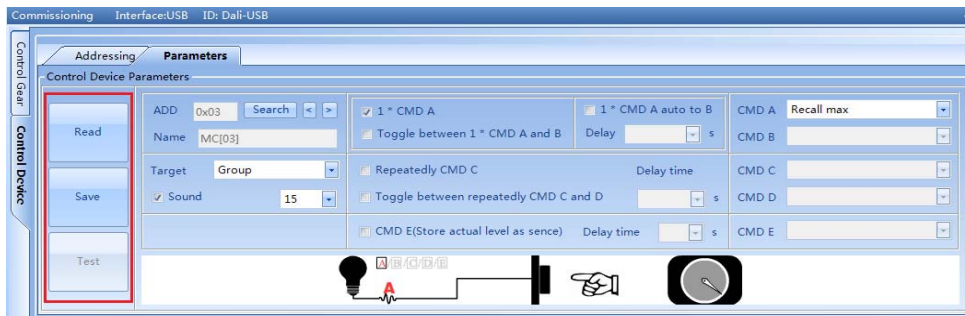

4.4.2.2 Motion Sensor parameterizing

Step1. Select a Motion Sensor. Click one of the “Motion Sensor” in Sensor tree for parameterizing.

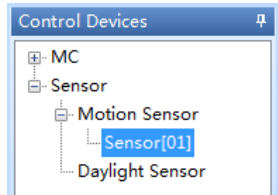

Step2. Enable the Motion Sensor.

On Control Device/Parameters page,

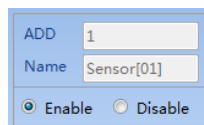
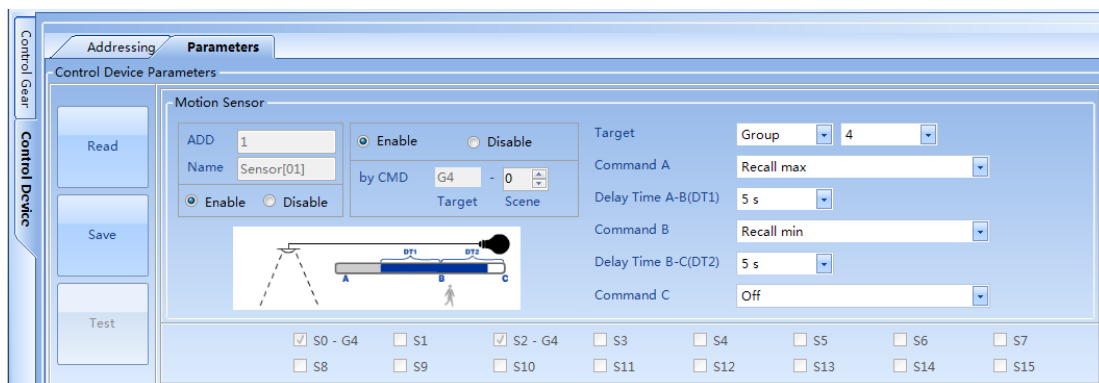

select “Enable” in  for activating this sensor. If “Disable” is selected, the sensor won’t work at any time.

Step3. Enable/disable Motion Sensor by Scene Command.

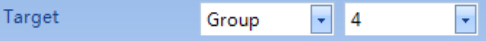
- Select an Control Gear(s) address in  for the controlling target of Motion Sensor and the target of scene command described below.

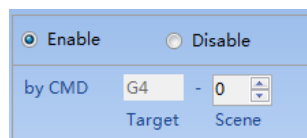

- Select one of scene0-15 in , select “Enable” means that the Motion Sensor will be triggered to working mode only while receiving a exact same scene command with “Target + Scene(n)” as setting. Select “Disable” means that the Motion Sensor will be disabled by receiving this scene command.

! Note: If the Scene is set with Enable option, the Control Gears of the setting Target are advised to be set as Mask.

Step4. Triggered Command setting.

Set the sending commands after the Motion Sensor triggered by human body movement, 3 basic sending commands A, B, C are illustrated in following table:

No.	Options	Descriptions
1	Command A <input type="text" value="Recall max"/>	While Motion Sensor is triggered by motion detection, command A will always be sent once immediately.
2	Command B <input type="text" value="Recall min"/>	When no movement is detected and after delay time of DT1, command B will be sent once.
3	Command C <input type="text" value="Off"/>	After command B is sent, if no movement is detected during the delay period of DT2, command C will be sent.
4	Delay Time A-B(DT1) <input type="text" value="5 s"/>	TD1 is the delay time from the Motion Sensor sensing no movement to B command sent.
5	Delay Time B-C(DT2) <input type="text" value="5 s"/>	DT2 is the delay time from B command sent to C command sent.

Step5. Save the settings.

Press button to save the settings of this Motion Sensor. If it is necessary to read the settings of current sensor, press button.

4.4.2.3 Daylight Sensor parameterizing

(to be continued...)